

Structural system FC

Contents

Support beams and small beams	3
Enclosure beams	5
Small beams	6
Enclosure components-conduit elements	7
Connectors-angle brackets	9
Connectors	12
Feet	16
Feet, polyamide	19
Feet-end plates	21
Screws	22

F45

FT

FS

FL

FLP

F65

FM

FMP

F85

F85P

FH

FK

FKP

FB140

FB175

FB295

SPIRAL

FW

FLX

FMX

FHX

FBX175

FBX295

ACC

CA

FC

TOOL

IDX

Support beams and small beams

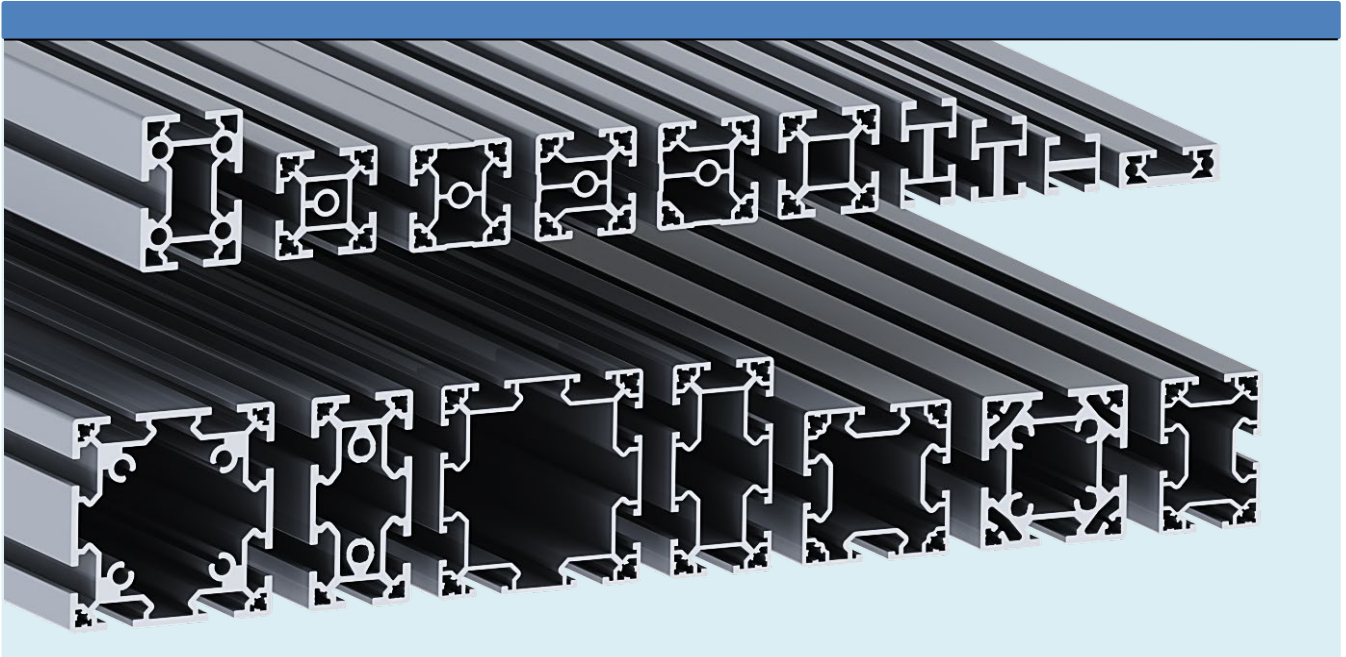

Support beams

FCBM 3X88

Beam 88 mm x 88 mm
Heavyweight version
Aluminium, anodized
Length 3 mt

FCBL 3X88

Beam 88 mm x 88 mm
Lightweight version
Aluminium, anodized
Length 3 mt

FCBE 88 End cap Polyamide

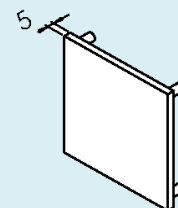
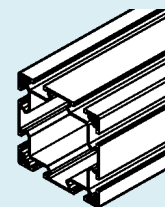
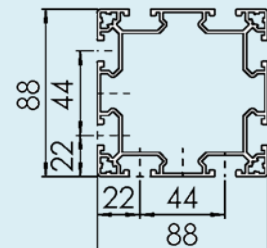
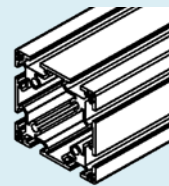
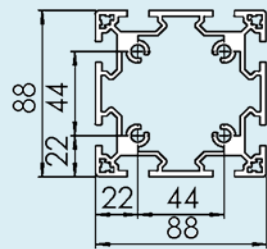

FCBM 3X44X88

Beam 44 mm x 88 mm
Heavyweight version
Aluminium, anodized
Length 3 mt

FCBL 3X44X88

Beam 44 mm x 88 mm
Lightweight version
Aluminium, anodized
Length 3 mt

FCBE 44X88 End cap Polyamide

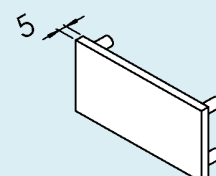
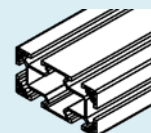
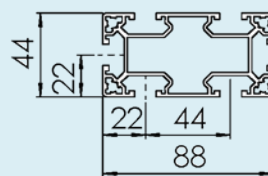
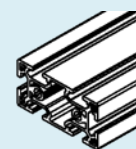
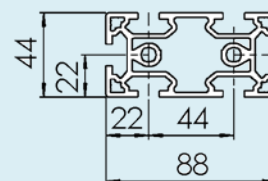

FCBM 3X64

Beam 64 mm x 64 mm
Heavyweight version
Aluminium, anodized
Length 3 mt

FCBL 3X64

Beam 64 mm x 64 mm
Lightweight version
Aluminium, anodized
Length 3 mt

FCBE 64 End cap Polyamide

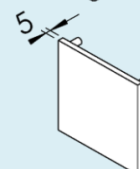
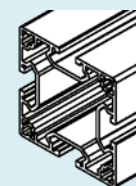
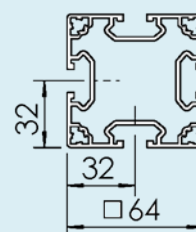
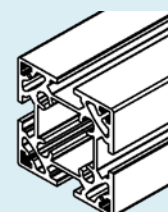
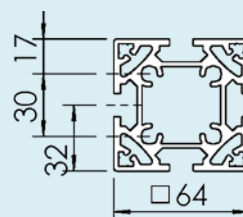

F45

FT

FS

FL

FLP

F65

FM

FMP

F85

F85P

FH

FK

FKP

FB140

FB175

FB295

SPIRAL

FW

FLX

FMX

FHX

FBX175

FBX295

ACC

CA

FC

TOOL

IDX

Support beams

FCBM 3X44X64

Beam 44 mm x 64 mm
Heavyweight version
Aluminium, anodized
Length 3 mt

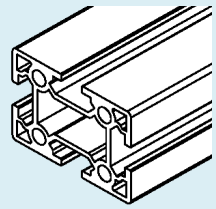
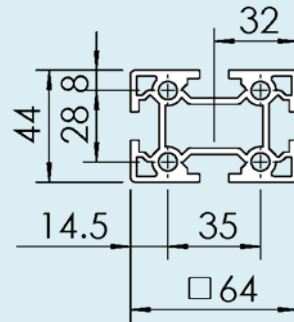

FCBL 3X44X64

Beam 44 mm x 64 mm
Lightweight version
Aluminium, anodized
Length 3 mt

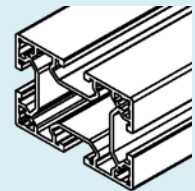
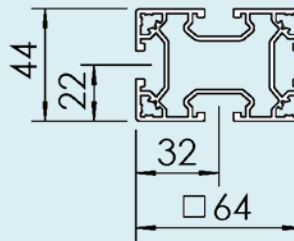

FCBE 44X64 End cap Polyamide

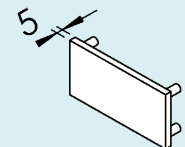

FCBM 3X44

Beam 44 mm x 44 mm
Heavyweight version
Aluminium, anodized
Length 3 mt

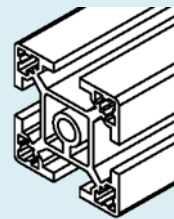
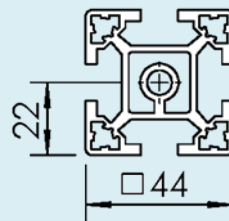

FCBL 3X44

Beam 44 mm x 44 mm
Lightweight version
Aluminium, anodized
Length 3 mt

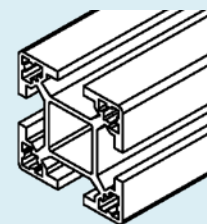
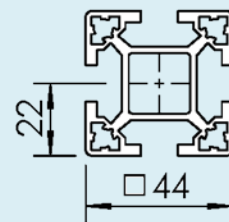

FCBE 44 End cap Polyamide

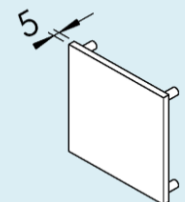

Enclosure beams

FCBL 3X44T2

Beam 44 mm x 44 mm with
two adjacent T-slots
Lightweight version
Aluminium, anodized
Length 3 mt

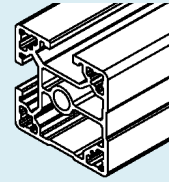
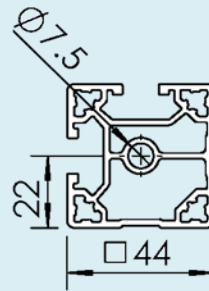

FCBL 3X44T2A

Beam 44 mm x 44 mm with
two opposite T-slots
Lightweight version
Aluminium, anodized
Length 3 mt

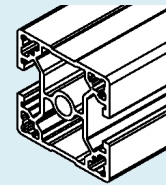
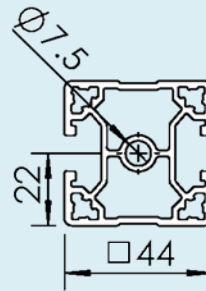

FCBL 3X44T3

Beam 44 mm x 44 mm with
three T-slots
Lightweight version
Aluminium, anodized
Length 3 mt

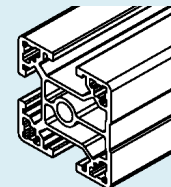
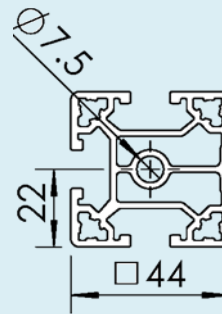

End cap for enclosure beams:
see FCBE 44

F45

FT

FS

FL

FLP

F65

FM

FMP

F85

F85P

FH

FK

FKP

FB140

FB175

FB295

SPIRAL

FW

FLX

FMX

FHX

FBX175

FBX295

ACC

CA

FC

TOOL

IDX

Small beams

FCBL 3X15X44

Beam 15 mm x 44 mm
Lightweight version
Aluminium, anodized
Length 3 mt

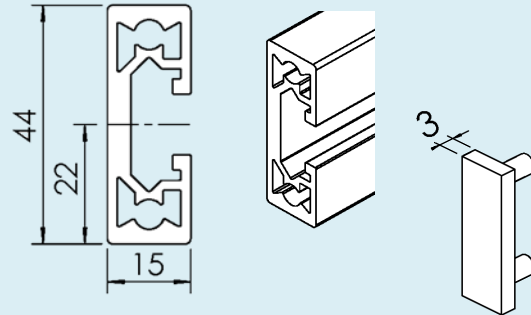

FCBE 15X44

End cap, Polyamide

FCBB 3X24X44

Beam 24 mm x 44 mm
Aluminium, anodized
Length 3 mt

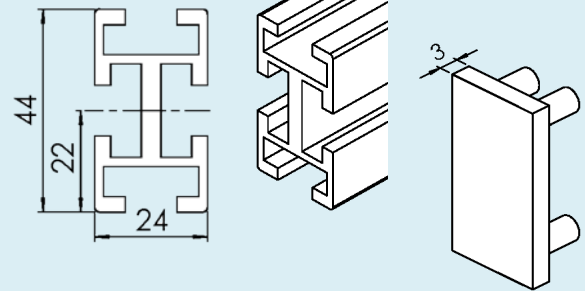

FCBE 24X44

End cap, Polyamide

FCBB 3X24X34

Beam 24 mm x 34 mm
Aluminium, anodized
Length 3 mt

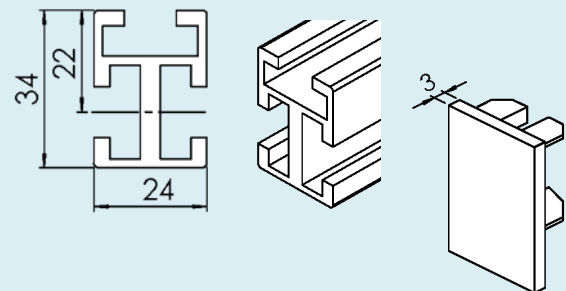

FCBE 24X34

End cap, Polyamide

FCBB 3X24

Beam 24 mm X 24 mm
Aluminium, anodized
Length 3mt

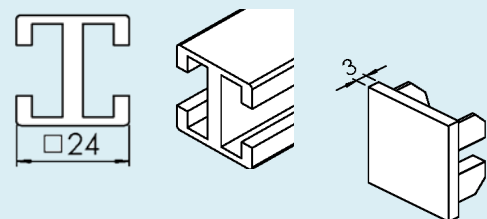

FCBE 24

End cap, Polyamide

FCAC 2

Cover strip
Length 2 mt
Aluminium, anodized

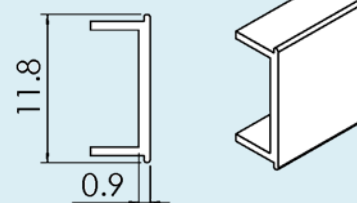

FCAC 3P

Cover strip
Length 3 mt
Polyvinyl chloride

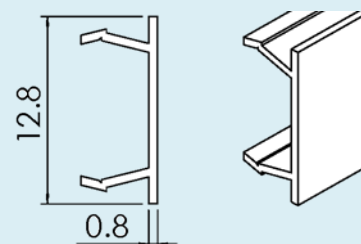

Small beams

FCAC 25P
 Cover strip for T-slot, PVC
 Length 25 mt
 Grey PVC

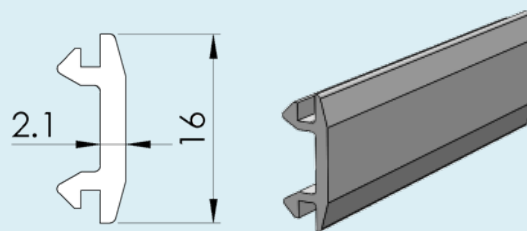

F45

FT

FS

FL

FLP

F65

FM

FMP

F85

F85P

FH

FK

FKP

FB140

FB175

FB295

SPIRAL

FW

FLX

FMX

FHX

FBX175

FBX295

ACC

CA

FC

TOOL

IDX

Enclosure components-conduit elements

FCCC 3X44

Cover for cable duct, 44 mm
Aluminium, anodized
Length 3mt

FCCD 3X44

Cable duct, 44 mm X 44 mm
Aluminium, anodized
Length 3mt

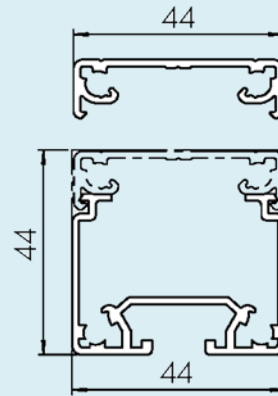

FCCC 3X88

Cover for cable duct, 88 mm
Aluminium, anodized
Length 3mt

FCCD 3X88

Cable duct, 88 mm X 88 mm
Aluminium, anodized
Length 3mt

FCCD 3X44X88

Cable duct, 44 mm X 88 mm
Aluminium, anodized
Length 3mt

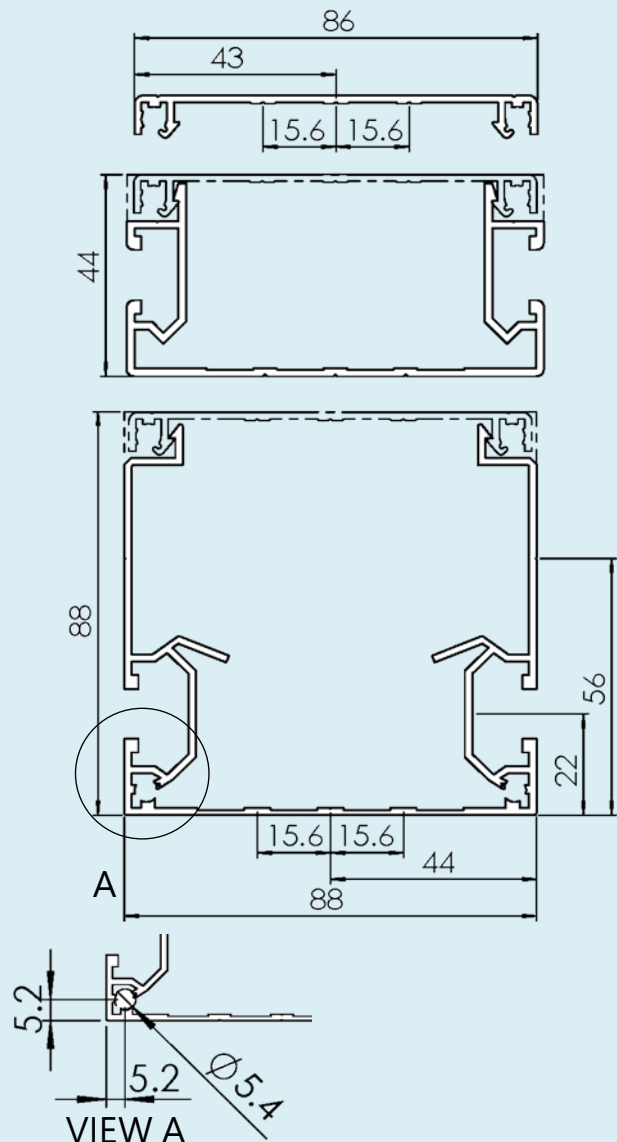

FCLB 20X30

Sliding element for T-slot
Ultra-high molecular weight
polyethylene

Including set screw

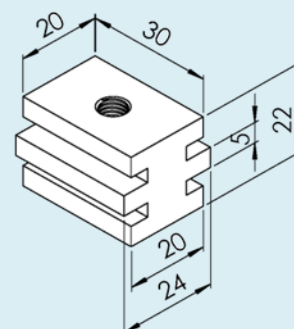

Connectors-angle brackets



F45

FT

FS

FL

FLP

F65

FM

FMP

F85

F85P

FH

FK

FKP

FB140

FB175

FB295

SPIRAL

FW

FLX

FMX

FHX

FBX175

FBX295

ACC

CA

FC

TOOL

IDX

Angle brackets, die-cast

FMFA 84A Angle bracket
Aluminium, die-cast
Mounting: M6S 8X16 (8)
BRB 8.4X16 (8), FCAN 8 (8)

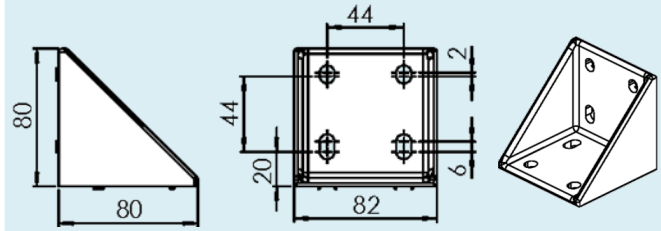

FMFA 84B Angle bracket
Aluminium, die-cast
Mounting: M6S 8X16 (4)
BRB 8.4X16 (4), FCAN 8 (4)

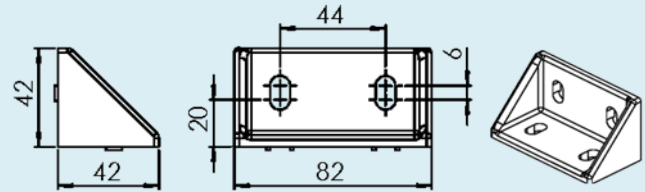

FLFA 44A Angle bracket
Aluminium, die-cast
Mounting: M6S 8X16 (4)
BRB 8.4X16 (4), FCAN 8 (4)

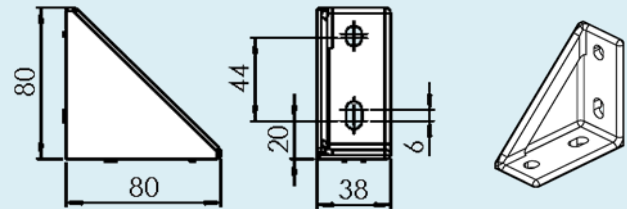

FLFA 44B Angle bracket
Aluminium, die-cast
Mounting: M6S 8X16 (2)
BRB 8.4X16 (2), FCAN 8 (2)

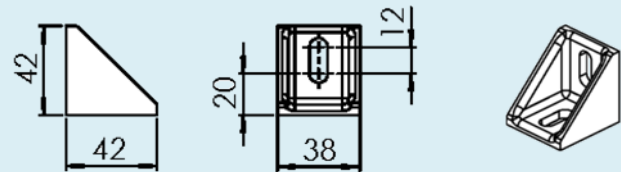

FLFA 44C Angle bracket
Aluminium, die-cast
Mounting: M6S 8X16 (3)
BRB 8.4X16 (3), FCAN 8 (3)

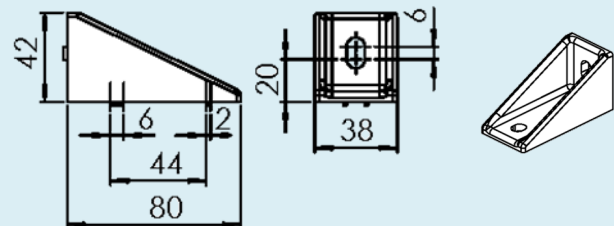

FLFA 44D Angle bracket
Aluminium, die-cast
Mounting: M6S 8X16 (5)
BRB 8.4X16 (5), FCAN 8 (5)

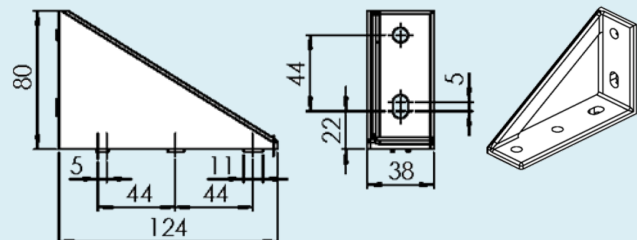

FLFA 24 Angle bracket
Aluminium, die-cast
Mounting: M6S 6X14 (2)
BRB 6.4X12 (2), FCAN 6 (2)

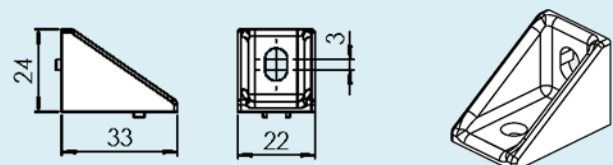

Angle brackets, extruded

<p>FMFA 84 Angle bracket Aluminium, die-cast Mounting: M6S 8X16 (6) BRB 8.4X16 (6), FCAN 8 (6)</p>		<p>F45 FT FS FL FLP F65 FM FMP F85</p>
<p>FLFA 44 Angle bracket Aluminium, die-cast Mounting: M6S 8X16 (2) BRB 8.4X16 (2), FCAN 8 (2)</p>		<p>F85P FH FK FKP FB140 FB175 FB295 SPIRAL</p>
<p>FCFJ 44 Stay bracket, including reversible guide lugs Zinc, die-cast Mounting: MLC6S 8X14 (2), FCAN 8 (2), (beam side) or MLC6S 8'30 (2) (beam end)</p>		<p>FW FLX FMX FHX FBX175 FBX295</p>
<p>FCFJ 44F Stay bracket, including reversible guide lugs Zinc, die-cast Mounting: MLC6S 8X14 (2), FCAN 8 (2), (beam side) or MLC6S 8'30 (2) (beam end)</p>		<p>ACC CA FC TOOL IDX</p>

Connectors-slot fasteners

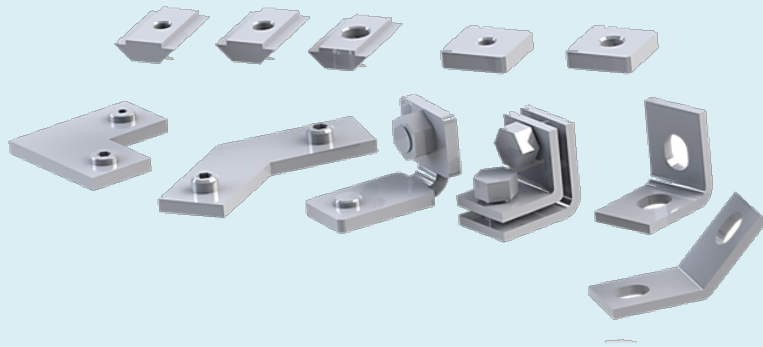

Slot nuts and nut profile

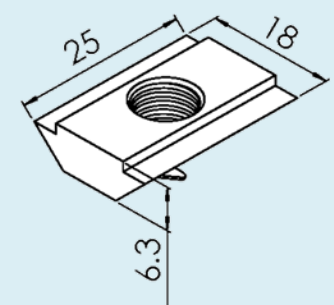
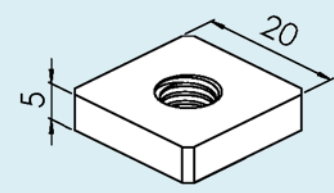
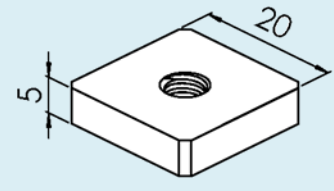
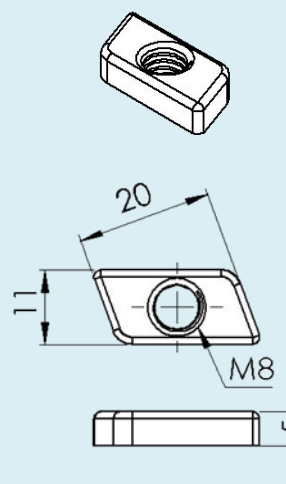
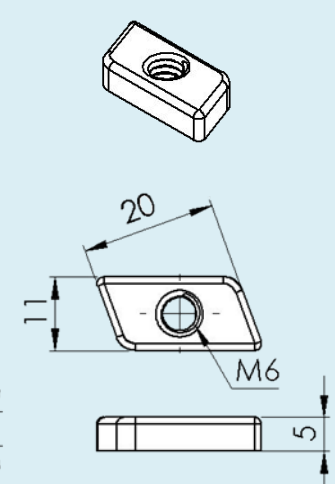
<p>FCAN 8 Slot nut, M8 thread Steel, zinc-chromated</p>		F45
<p>FCAN 6 Slot nut, M6 thread Steel, zinc-chromated</p>		FT
<p>FCAN 5 Slot nut, M5 thread Steel, zinc-chromated</p>		FS
<p>FLAQ 8 Square nut, M8 thread Steel, electro-zinc-plated</p> <p>FLAQ 6 Square nut, M6 thread Steel, electro-zinc-plated</p>	 	FL
		FLP
<p>FLAR 8 Rhombus nut, M8 thread</p> <p>FLAR 6 Rhombus nut, M6 thread</p>	 	F65
		FM
		FMP
		F85
		F85P
		FH
		FK
		FKP
		FB140
		FB175
		FB295
		SPIRAL
		FW
		FLX
		FMX
		FHX
		FBX175
		FBX295
		ACC
		CA
		FC
		TOOL
IDX		

Connecting strips

FLCJ 5X140

Connecting strip with M8 set screws
Length 140 mm
Steel, electro-zinc-plated

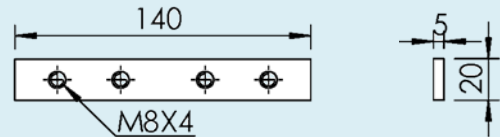

FLCJ 5X76

Connecting strip, M8 thread
Length 76 mm
Steel, electro-zinc-plated

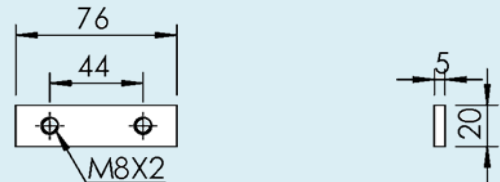

FSCJ 6X130

Connecting strip, M8 thread
Length 130 mm
Steel, electro-zinc-plated

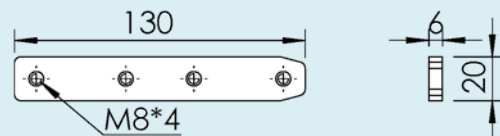

FSCJ 6X160

Connecting strip, M8 thread
Length 160 mm
Steel, electro-zinc-plated

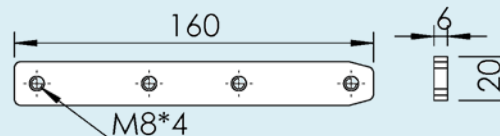

FLCJ 6X130

Connecting strip, M8 thread
Length 130 mm
Steel, electro-zinc-plated

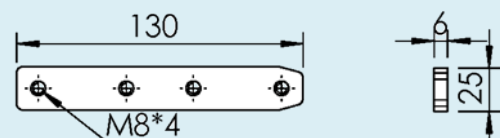

FLCJ 6X140

Connecting strip, M8 thread
Length 140 mm
Stainless steel

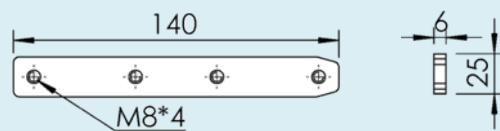

FLCJ 6X160

Connecting strip, M8 thread
Length 140 mm
Stainless steel

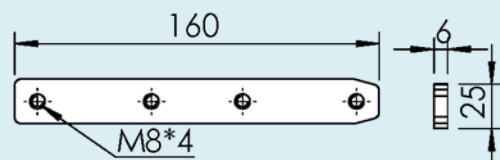

FCFP 75

Parallel connector assembly for connecting beams T-slot to T-slot
Length 75 mm
Aluminium, anodized

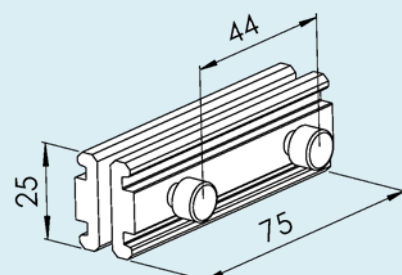

Connectors-small fittings

FMRX 20

Inner fitting 90°
Including T-Bolt, nut,
set screw

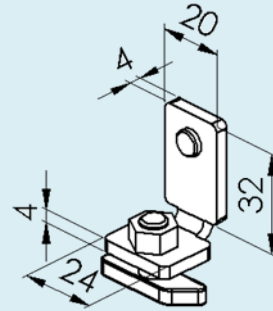

FMRX 20A

Inner fitting 90°
Including set screw
Steel, electro-zinc-plated
Mounting: M6S 8X14 (1)
BRB 8.4X16 (1)
FCAN 8 (1)

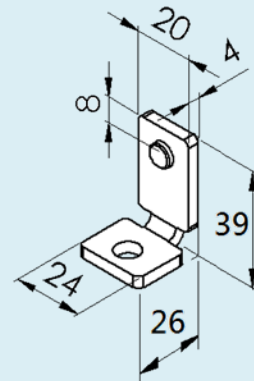

FMRY 20

Inner fitting 90°, double
Including screws

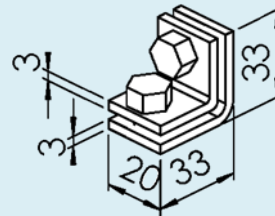

FMRY 20A

Inner fitting 90°
Mounting: M6S 8X14 (2)
BRB 8.4X16 (2)
FCAN 8 (2)

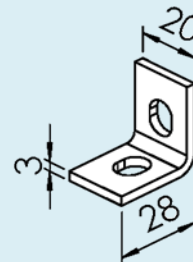

F45

FT

FS

FL

FLP

F65

FM

FMP

F85

F85P

FH

FK

FKP

FB140

FB175

FB295

SPIRAL

FW

FLX

FMX

FHX

FBX175

FBX295

ACC

CA

FC

TOOL

IDX

Connectors-small fittings

FMRY 20B
Inner fitting 90°
Including set screws

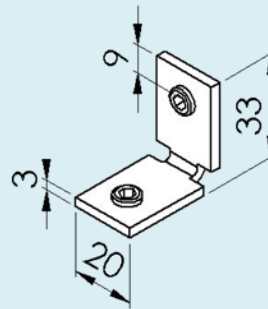

FMRY 20X45A
Inner fitting 45°
Mounting:
M6S 8X14 (2)
BRB 8.4X16 (2)
FCAN 8 (2)

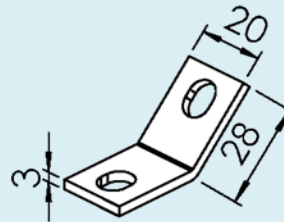

FMRW 20
Corner fitting 90°
Including set screws

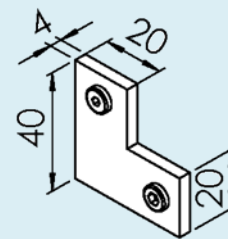

FMRW 20X45
Corner fitting 45°
Including set screws

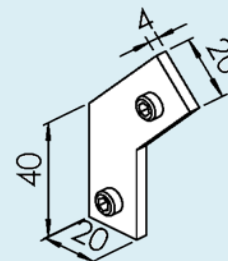

Feet

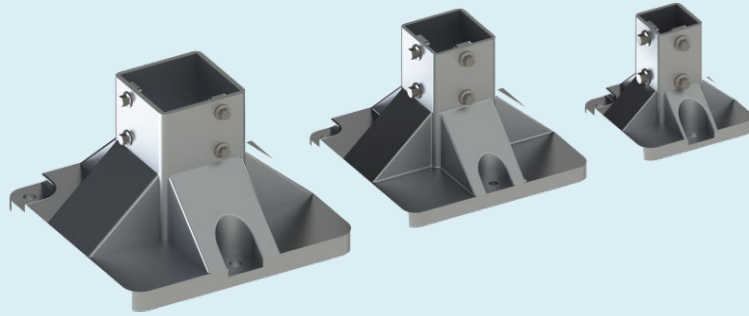

F45

FT

FS

FL

FLP

F65

FM

FMP

F85

F85P

FH

FK

FKP

FB140

FB175

FB295

SPIRAL

FW

FLX

FMX

FHX

FBX175

FBX295

ACC

CA

FC

TOOL

IDX

Feet

Feet
Including fastener kit
Aluminium, die-cast

FCFF 88X260A

Foot for beam FCBM/FCML..X88
Max. bending moment 1500 Nm

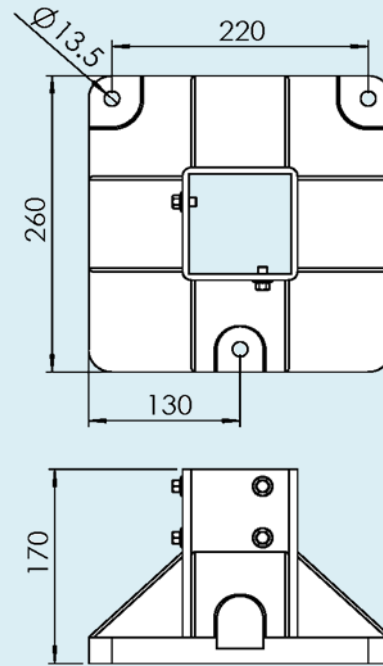

FCFF 64X210A

Foot for beam FCBM/FCML..X64
Max. bending moment 750 Nm

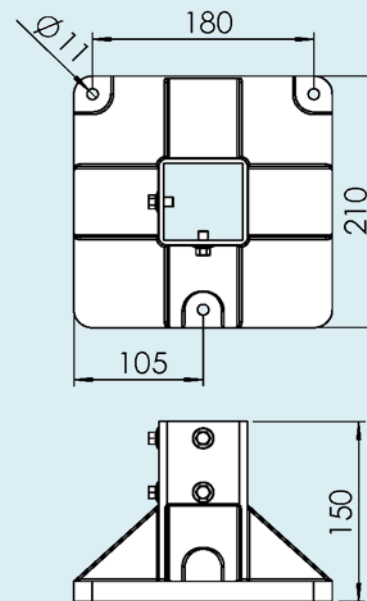

FCFF 44X130A

Foot for beam FCBM/FCML..X44
Max. bending moment 250 Nm

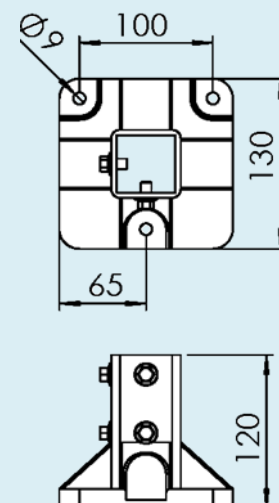

Feet

Mounting plate 145X145

FCFB 88F

Foot plate for beam

FCBM/FCBL..X88

Aluminium, anodized

Mounting: MF6S 8X30 (4)

or MF6S 6X30 (4)

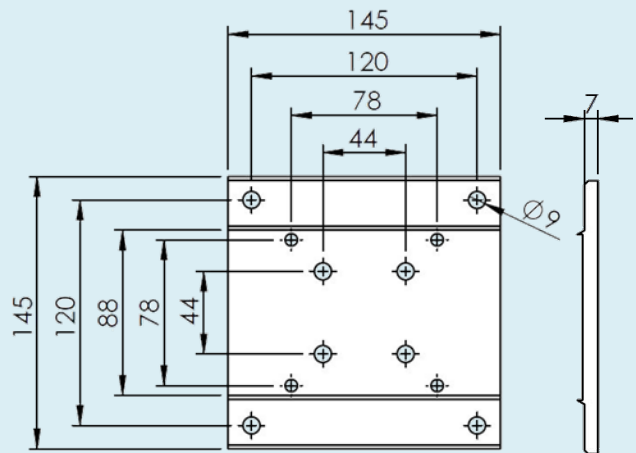

Mounting plate 88X145

FCFB 88

Foot plate for beam FCBM 3X88

Aluminium, anodized

Mounting: M6S 8X18 (4) BRB8.4X16 (4)

FCAN 8(4), MF6S 8X30 (4)

Cannot be used with FCBL beams.

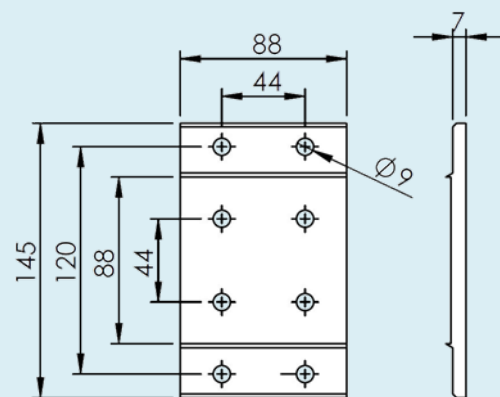

Mounting plate 88X100

FCFB 44X88B

Foot plate for beam FCBM 3X44X88

Aluminium, anodized

Mounting: M6S 8X18 (4) BRB8.4X16 (4)

FCAN 8(4), MF6S 8X30 (2)

Cannot be used with FCBL beams.

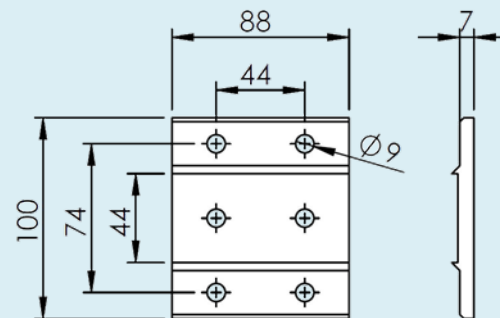

Mounting plate 64X120

FCFB 64A

Foot plate for beam FCBM 3X64

Mounting: M6S 8x18 (2),

BRB 8,4x16 (2), FCAN 8 (2)+

MF6S 8x30 (4).

Cannot be used with FCBL beams.

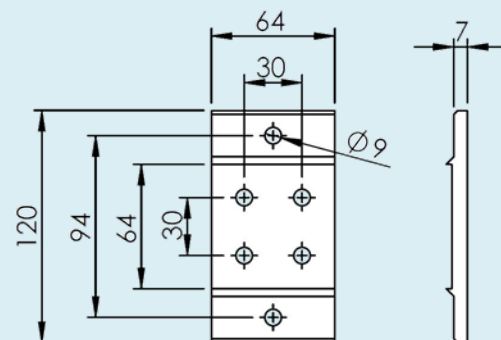

F45

FT

FS

FL

FLP

F65

FM

FMP

F85

F85P

FH

FK

FKP

FB140

FB175

FB295

SPIRAL

FW

FLX

FMX

FHX

FBX175

FBX295

ACC

CA

FC

TOOL

IDX

Feet

Mounting plate 44X120

FCFB 44X64A

Foot plate for beam FCBM 44X64 mm

Aluminium, anodized

Mounting: M6S 8X18 (2)

BRB 8.4X16 (2), FCAN 8 (2)+

MF6S 8X30 (4)

Cannot be used with FCBL beams

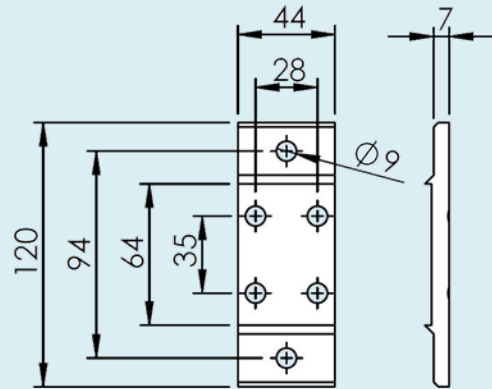

Mounting plate 44X100

FCFB 44X64B

Foot plate for beam FCBM 44X64 mm

Aluminium, anodized

Mounting: M6S 8X18 (2)

BRB 8.4X16 (2), FCAN 8 (2)+

MF6S 8X30 (4)

Cannot be used with FCBL beams

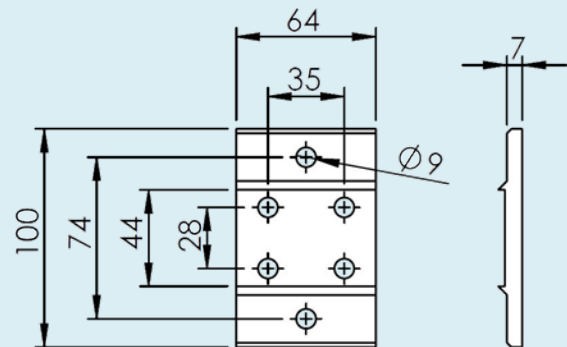

Mounting plate 44X145

FCFB 44X88A

Foot plate for beam FCBM 3X44X88

Aluminium, anodized

Mounting: M6S 8X18 (4) BRB8.4X16 (2)

FCAN 8(2), MF6S 8X30 (2)

Cannot be used with FCBL beams.

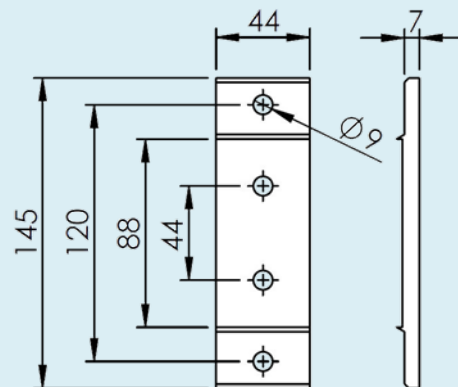

Mounting plate 44x100

FCFB 44

Foot plate for beam FCBM 3X44 mm

Aluminium, anodized

Mounting: M6S 8x18 (2),

BRB 8,4x16 (2), FCAN 8 (2) +

MF6S 8x30 (1)

Cannot be used with FCBL beams

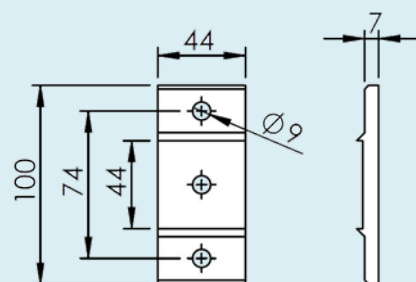

Feet

Adjustable foot, including nut

FCFS 12X56

M12 thread, Mounting: FCFE..M12

FCFS 12X60X71

PA + steel, electro-zinc-plated
M12 thread, Mounting: FCFE...M12

FCFS 12X56

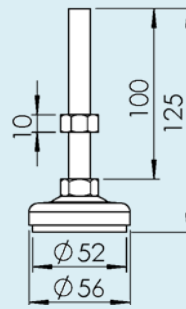

FCFS 12X60X71

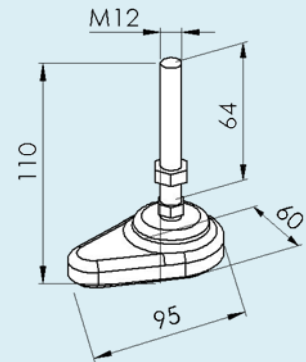

Guide rollers

Including fastener kit
Steel, electro-zinc-plated
Mounting: FCFE ..M12
Max. vertical load 600 N

FCAG 80A Guide roller

FCAG 80BA Guide roller with
multistop brake

FCAG 80 A

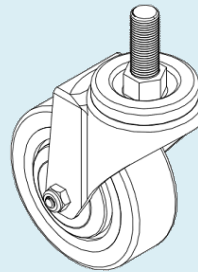

FCAG 80 BA

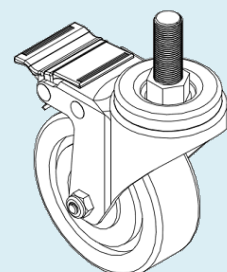

F45

FT

FS

FL

FLP

F65

FM

FMP

F85

F85P

FH

FK

FKP

FB140

FB175

FB295

SPIRAL

FW

FLX

FMX

FHX

FBX175

FBX295

ACC

CA

FC

TOOL

IDX

Feet for 64 mm beam

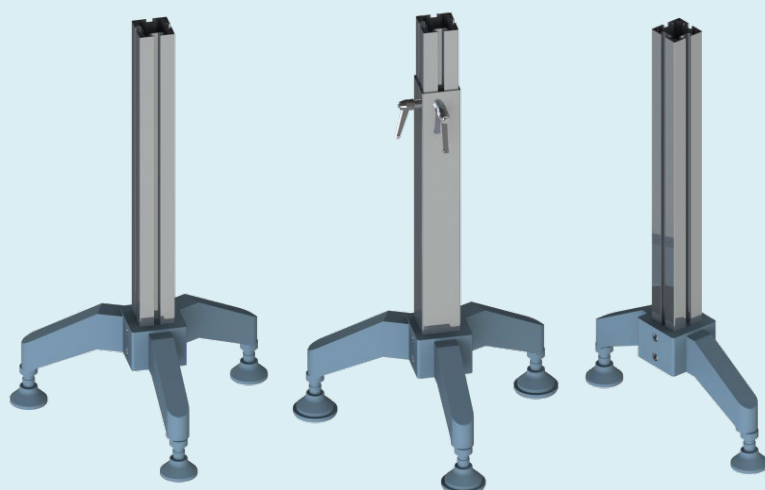

Feet, polyamide, for 64 mm beam

FEFG 64T

Three-point foot for FC..64 beam

D=64 mm

Incl. screws and clamps

Polyamide, glass-fibre reinforced

Max. vertical load 800 N

FEFG 70T

Three-point foot for FEFU 500

D=70 mm

Incl. screws and clamps

Polyamide, glass-fibre reinforced

Max. vertical load 800 N

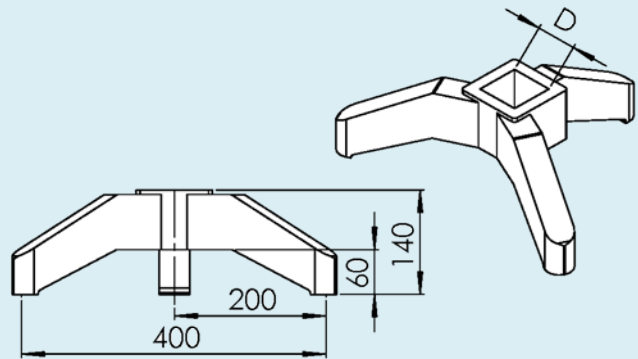

FEFG 64D

Two-point foot for FC..64

D=64 mm

Incl. screws and clamps

Polyamide, glass-fibre reinforced

Max. vertical load 800 N

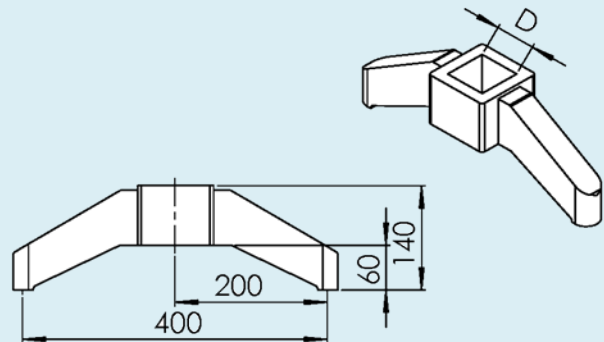

FLFS 20P

Adjusting foot for FEFG 64/70 T/D

Polyamide glass-fibre reinforced

With ball joint and M20 locking nut

FLFJ 69

Vibration absorber

For FLFS 20 P

Thermoplastic polyester

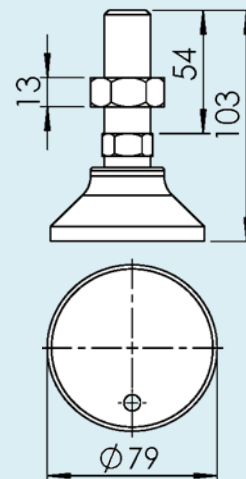

FEFU 500

Square section tube height adjustment assembly for FEFG 70 T

Including locking levers

Length 500 mm

Aluminium, anodized

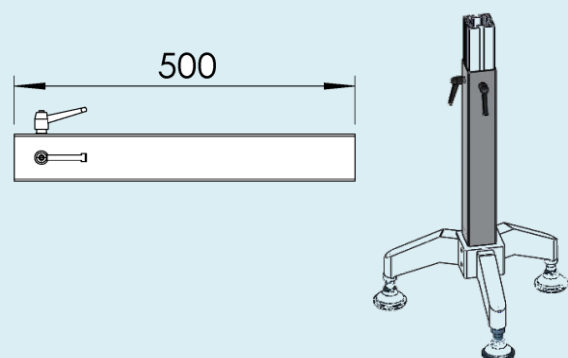

F45

FT

FS

FL

FLP

F65

FM

FMP

F85

F85P

FH

FK

FKP

FB140

FB175

FB295

SPIRAL

FW

FLX

FMX

FHX

FBX175

FBX295

ACC

CA

FC

TOOL

IDX

Feet-end plates

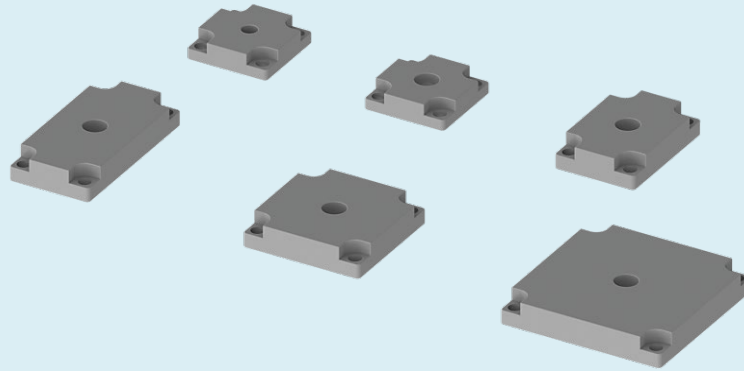

End plates

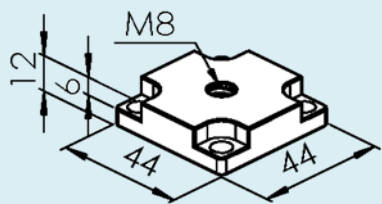
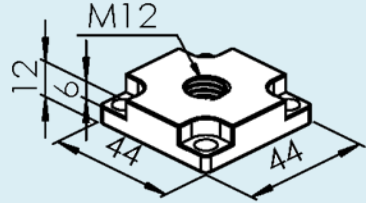
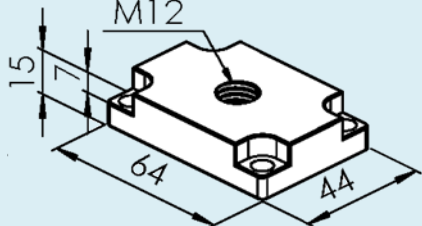
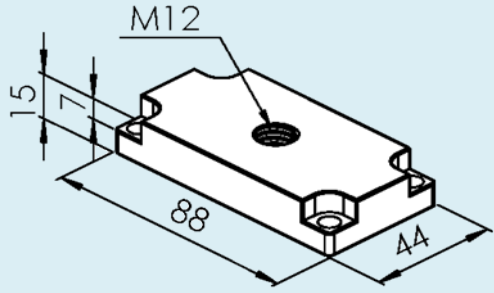
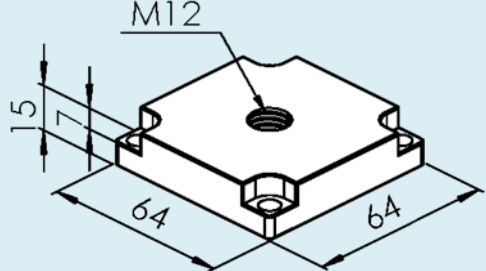
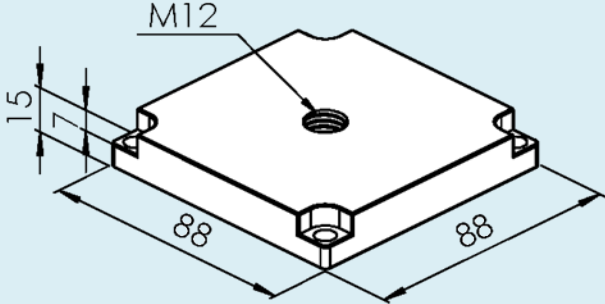
<p>FCFE 44M8 End plate for beam FCBL...X44, M12 thread Zinc, die-cast Mounting: MC6S 6X30 (4)</p>		<p>F45 FT FS FL FLP</p>
<p>FCFE 44M12 End plate for beam FCBL...X44, M8 thread Zinc, die-cast Mounting: MC6S 6X30 (4)</p>		<p>F65 FM FMP F85 F85P</p>
<p>FCFE 44X64M12A End plate for beam FCBL/FCBM...X44X64, M12 thread Zinc, die-cast Mounting: MC6S 6X30 (4)</p>		<p>FH FK FKP FB140 FB175</p>
<p>FCFE 44X88M12A End plate for beam FCBL/FCBM...X44X64, M12 thread Zinc, die-cast Mounting: MC6S 6X30 (4)</p>		<p>FB295 SPIRAL FW FLX FMX FHX</p>
<p>FCFE 64M12A End plate for beam FCBL/FCBM...X64, M12 thread Zinc, die-cast Mounting: MC6S 6X30 (4)</p>		<p>FBX175 FBX295 ACC CA FC</p>
<p>FCFE 88M12A End plate for beam FCBL/FCBM...X88, M12 thread Zinc, die-cast Mounting: MC6S 6X30 (4)</p>		<p>TOOL IDX</p>

Screws

T-bolts

FLAT 17	L= 17 mm
FLAT 24	L= 24 mm
FLAT 35	L= 35 mm
FLAT 53	L= 53 mm
FLAT 71	L= 71 mm

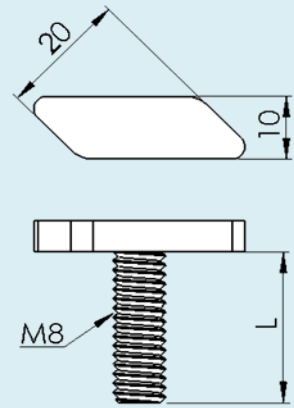

Nut

FLAN 8	Locking nut M8 for T-bolt, include washer BRB 8,4X16
---------------	---

FLAN 8

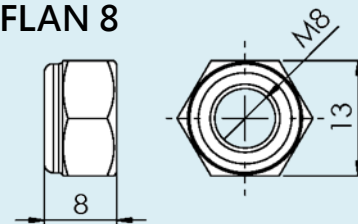

BRB 8,4X16	Washer
-------------------	--------

BRB 8,4X16

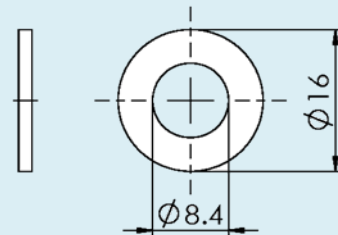

Screws

Hex head screws - DIN ISO 4017

- M6S 5X12** M5, L=12mm, \varnothing 5mm
- M6S 8X14** M8, L=14mm, \varnothing 8mm
- M6S 8X16** M8, L=16mm, \varnothing 8mm
- M6S 8X18** M8, L=18mm, \varnothing 8mm
- M6S 8X30** M8, L=30mm, \varnothing 8mm

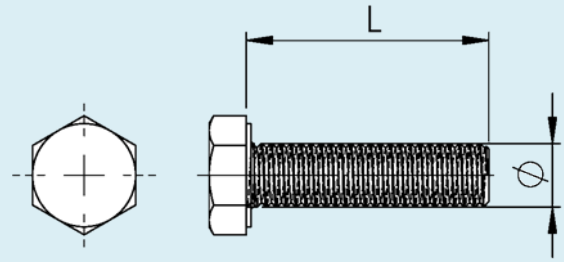

Hex socket head screws,
standard - DIN 912, ISO 4762

- MC6S 5X16** M5, L=16mm, \varnothing 5mm
- MC6S 6X16** M6, L=16mm, \varnothing 6mm
- MC6S 6X20** M6, L=20mm, \varnothing 6mm

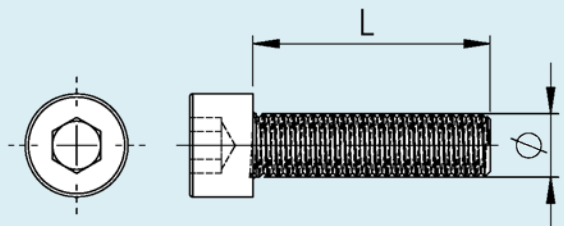

Hex socket head screws,
low profile - DIN 7984

- MLC6S 8X14** M8, L=14mm, \varnothing 8mm
- MLC6S 8X16** M8, L=16mm, \varnothing 8mm
- MLC6S 8X20** M8, L=20mm, \varnothing 8mm
- MLC6S 8X25** M8, L=25mm, \varnothing 8mm

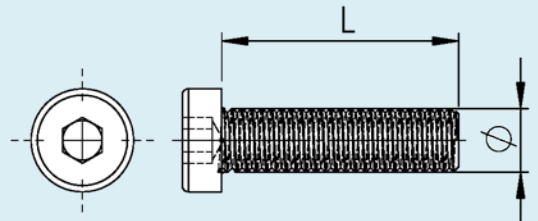

Hex socket head screws,
countersunk - DIN 7991

- MF6S 6X12** M6, L=12mm, \varnothing 6mm
- MF6S 6X14** M6, L=14mm, \varnothing 6mm
- MF6S 6X16** M6, L=16mm, \varnothing 6mm
- MF6S 6X30** M6, L=30mm, \varnothing 6mm

- MF6S 8X18** M8, L=18mm, \varnothing 8mm
- MF6S 8X30** M8, L=30mm, \varnothing 8mm
- MF6S 8X40** M8, L=40mm, \varnothing 8mm

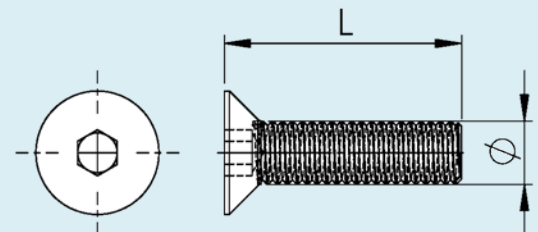

F45

FT

FS

FL

FLP

F65

FM

FMP

F85

F85P

FH

FK

FKP

FB140

FB175

FB295

SPIRAL

FW

FLX

FMX

FHX

FBX175

FBX295

ACC

CA

FC

TOOL

IDX

